

Project	
Date	
Prepared By	
Model #	HBL9240WH5

## Specifications

### ELECTRICAL

Watts: 92  
 Voltage: 120-347VAC  
 Power Factor: >0.9  
 THD: ≤10%  
 Operating Temp. Range:  
 -20°C (-4°F) to 50°C (122°F)

### LIGHT

Initial Lumens: 13800  
 Lumens per Watt: 150  
 Color Temperature: 4000K  
 CRI: 82  
 Dimming: 0-10V  
 Dimmable: Yes

### AGENCY APPROVALS

UL: Yes  
 RoHS: Yes  
 DLC® Premium: Yes

### PRODUCT DETAILS

Housing: Steel  
 Lens: PMMA optical glare-control lens  
 Warranty: 5 years  
 Fixture  
 Rated Life: 50,000 hours  
 Lumen Maintenance:  
 L70 at 100,000 hrs  
 Weight: 7.5 LBS  
 Dimensions:  
 16.62" L x 10.25" W x 2.0" D



Norton Shores, Michigan 49441  
 T: 231.332.1188 | F: 231.726.5029  
 TOLL FREE: 866.632.7840  
 www.earthtronics.com

# HBL-1 High Bay Premium Series

13800 Lumens, 92 Watt, 4000K, 120-347V



**ORDER CODE:**  
11701

**MODEL NUMBER:**  
HBL9240WH5

**LENGTH:**  
1.3 ft

**DLC PRODUCT ID:**  
S-SROZ1T

**REBATE AVAILABILITY\***



## PRODUCT DESCRIPTION

EarthTronics LED High Bay offers a small, lightweight design that delivers excellent energy savings without sacrificing performance. This 92-watt LED High Bay has a 1.3ft design and provides 13800 lumens. It features a durable steel housing and the 4000K color temperature with a high 80+ CRI providing excellent visual acuity for accuracy when working in manufacturing and warehousing applications. Various mounting options are available.

## PRODUCT FEATURES

- + Lightweight, compact design
- + 120-347VAC 50-60Hz
- + Operating at 150 lumens per watt
- + 6kV ANSI surge protection standard
- + Integral LED lens is constructed from PMMA and provides even illumination across the face of the high bay
- + Durable steel housing
- + Up to 50°C true ambient temperature
- + 6ft 18/3 SJT cord sold separately (see available options)
- + DLC® Premium
- + Driver standard with 0-10V dimming (prewired)
- + Suitable for damp locations
- + Dimmable
- + 100,000 hours rated life L70
- + Hanging hardware included V-Hooks & chain
- + Emergency back-up driver available
- + Compatible with EarthConnect® Network Lighting Controls

## APPLICATIONS

- + Manufacturing Facility
- + Warehouse
- + Auditorium
- + Cafeteria
- + Gymnasium

Please consult installation instructions for proper application and use of this fixture.  
 \*Rebate availability access it here: [www.earthtronics.com/rebate-finder](http://www.earthtronics.com/rebate-finder)

## PACKAGE DETAILS

Individual Carton Qty: 1

Dimensions:

17.28" L x 10.5" W x 2.00" H

Weight: 7.5 LBS

UPC: 840791117019

Master Carton Qty: 4

Dimensions:

175" L x 11.0" W x 9.0" H

Weight: 30 LBS

UPC: 84079111701900

## PRODUCT DIMENSIONS

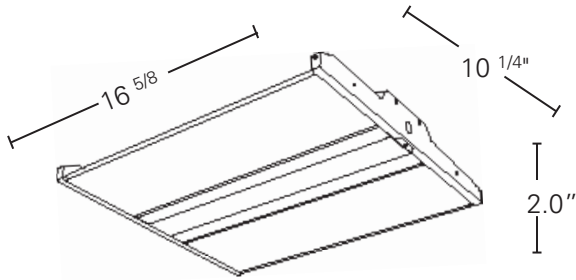

## LIGHTING LAYOUT

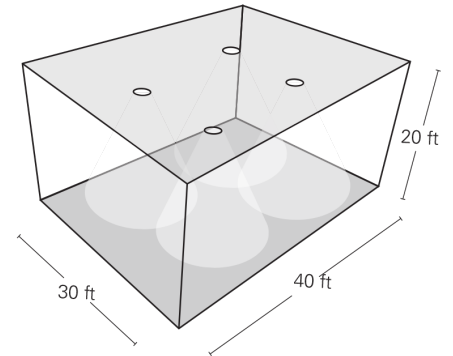

Average Illuminance: 30 fc

Number of Luminaires: 4

Workplane Height: 2.5 ft

## OPTIONAL ACCESSORIES

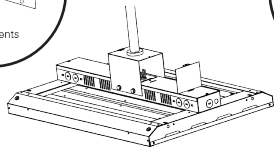
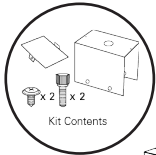

**Pendant Hanger**  
Order Code: 11711

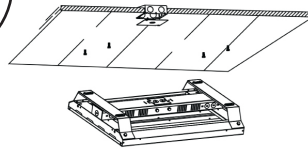
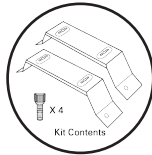

**Surface Mount**  
Order Code: 11710

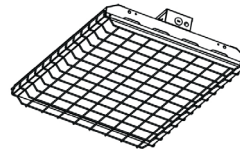

**Wire Guard**  
Order Code: 11712



**12VDC PIR Motion Sensor**  
Order Code: 11709  
Remote Order Code: 11810

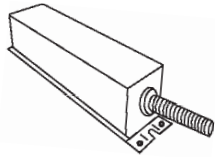

**External Emergency  
Back up Kit (30W)**  
Order Code: 11617

### 6ft 18/3 SJT cord available (sold separately)

Order Code: 11836 6ft 18/3 SJTOOW 300V Cord - White (cord only)

Order Code: 11837 6ft Cord (18/3 SJT White) with 5-15P 120V 15AMP Plug  
Straight Blade Plug - Black

Order Code: 11838 6ft Cord (18/3 SJT White) with NEMA L7-15P 277V 15AMP  
Twist Lock Plug - Black

Easily access our DLC qualified products with rebates in your area.

ACCESS IT HERE: [Rebate Finder - Linear LED Highbay](#)

[www.earthtronics.com/rebate-finder/catalog/](http://www.earthtronics.com/rebate-finder/catalog/)

