

Project	
Date	
Prepared By	
Model #	HBL9250WH1

Specifications

ELECTRICAL

Watts: 92
 Voltage: 120-277VAC
 Power Factor: >0.9
 THD: ≤10%
 Operating Temp. Range:
 -20°C (-4°F) to 50°C (122°F)

LIGHT

Initial Lumens: 13800
 Lumens per Watt: 150
 Color Temperature: 5000K
 CRI: 82
 Dimming: 0-10V
 Dimmable: Yes

AGENCY APPROVALS

UL: Yes
 RoHS: Yes
 DLC® Premium: Yes

PRODUCT DETAILS

Housing: Steel
 Lens: PMMA optical glare-control lens
 Warranty: 5 years
 Fixture
 Rated Life: 50,000 hours
 Lumen Maintenance:
 L70 at 100,000 hrs
 Weight: 7.5 LBS
 Dimensions:
 16.62" L x 10.25" W x 2.0" D

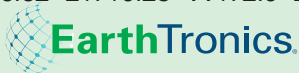

Norton Shores, Michigan 49441
 T: 231.332.1188 | F: 231.726.5029
 TOLL FREE: 866.632.7840
 www.earthtronics.com

HBL-1 High Bay Premium Series

13800 Lumens, 92 Watt, 5000K, 120-277V



ORDER CODE:
11685

MODEL NUMBER:
HBL9250WH1

LENGTH:
1.3 ft

DLC PRODUCT ID:
S-JVLYPB

REBATE AVAILABILITY*



PRODUCT DESCRIPTION

EarthTronics LED High Bay offers a small, lightweight design that delivers excellent energy savings without sacrificing performance. This 92-watt LED High Bay has a 1.3ft design and provides 13800 lumens. It features a durable steel housing and the 5000K color temperature with a high 80+ CRI providing excellent visual acuity for accuracy when working in manufacturing and warehousing applications. Various mounting options are available.

PRODUCT FEATURES

- + Lightweight, compact design
- + 120-277VAC 50-60Hz
- + Operating at 150 lumens per watt
- + 6kV ANSI surge protection standard
- + Integral LED lens is constructed from PMMA and provides even illumination across the face of the high bay
- + Durable steel housing
- + Up to 50°C true ambient temperature
- + 6ft 18/3 SJT cord sold separately (see available options)
- + DLC® Premium
- + Driver standard with 0-10V dimming (prewired)
- + Suitable for damp locations
- + Dimmable
- + 100,000 hours rated life L70
- + Hanging hardware included V-Hooks & chain
- + Emergency back-up driver available
- + Compatible with EarthConnect® Network Lighting Controls

APPLICATIONS

- + Manufacturing Facility
- + Warehouse
- + Auditorium
- + Cafeteria
- + Gymnasium

Please consult installation instructions for proper application and use of this fixture.
 *Rebate availability access it here: www.earthtronics.com/rebate-finder

PACKAGE DETAILS

Individual Carton Qty: 1
 Dimensions:
 17.28" L x 10.5" W x 2.00" H
 Weight: 7.50 LBS
 UPC: 840791116852

Master Carton Qty: 4
 Dimensions:
 175" L x 11.0" W x 9.0" H
 Weight: 30 LBS
 UPC: 84079111685200

PRODUCT DIMENSIONS

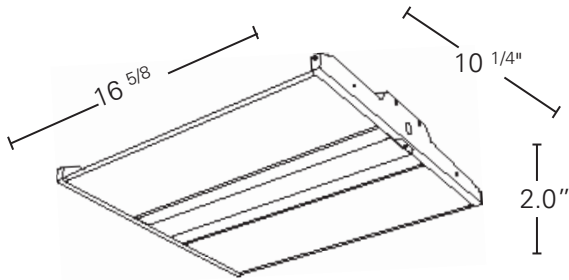

Average Illuminance: 30 fc
 Number of Luminaires: 4
 Workplane Height: 2.5 ft

LIGHTING LAYOUT

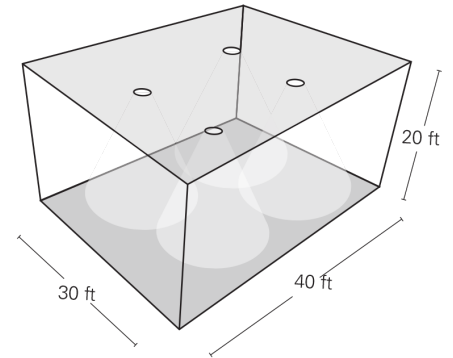

OPTIONAL ACCESSORIES

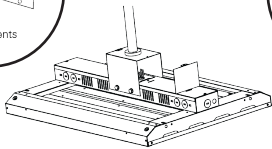

Pendant Hanger
 Order Code: 11711

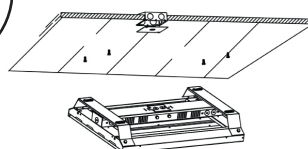
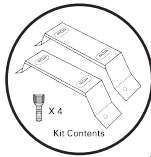

Surface Mount
 Order Code: 11710

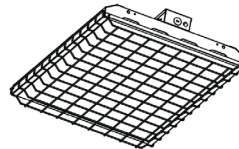

Wire Guard
 Order Code: 11712



12VDC PIR Motion Sensor
 Order Code: 11709
 Remote Order Code: 11810

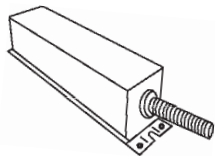

External Emergency Back up Kit (30W)
 Order Code: 11617

6ft 18/3 SJT cord available (sold separately)

- Order Code: 11836 6ft 18/3 SJTOOW 300V Cord - White (cord only)
- Order Code: 11837 6ft Cord (18/3 SJT White) with 5-15P 120V 15AMP Plug
Straight Blade Plug - Black
- Order Code: 11838 6ft Cord (18/3 SJT White) with NEMA L7-15P 277V 15AMP
Twist Lock Plug - Black

Easily access our DLC qualified products with rebates in your area.

ACCESS IT HERE: [Rebate Finder - Linear LED Highbay](#)

www.earthtronics.com/rebate-finder/catalog/

